



ELITE
GREENHOUSES LTD
B R I T T O N



LET'S GROW TOGETHER
www.elite-greenhouses.co.uk
www.greatbritton.ru





*Family
is not just an
important thing
....
It's everything*

CONGRATULATIONS!

You are on the first step towards owning an Elite Greenhouse. Selecting a greenhouse can be a complicated and confusing process with so many models, manufacturers and variants to choose from. We, as the manufacturer, are here every step of the way to help you, make you feel at ease, and highlight what you can expect to receive for your money.

WHO?

We are Elite Greenhouses Limited and are proud to say we are a privately owned, third generation UK family business, celebrating its Diamond Jubilee year in 2013. In such an ever changing "throw away" culture, we continue to manufacture, right here in the UK, the widest range and one of the strongest aluminium greenhouses money can buy.

WHAT?

Despite having thousands of happy customers over the last 60 years, we have never lost sight of our founders' vision to demand excellence and complete satisfaction. We are passionate and enthusiastic about greenhouses and continue to produce a life long product, backed by a 10 year guarantee, made right here in the UK and delivered by our own fleet of vehicles to your home.



We guarantee that no aluminium part will rust, warp or be of unmerchantable quality. Excludes glazing or weather damage.

WHERE?

At Elite Greenhouses we only manufacture our products from our plant in Bolton, Lancashire and do not sell direct. We have hundreds of loyal, hard-working and well established authorised dealers displaying our products the length and breadth of the UK, so you are sure to be near to a site where one of our helpful and friendly agents can assist you with any enquiry. To find where your nearest agent is or for any further information please feel free to contact us on 01204 791488 or via email at enquiries@elite-greenhouses.co.uk.

HOW?

To become part of the Elite Greenhouse family and begin to enjoy the pleasures and benefits which our products offer, for many years to come, simply choose the model of your choice from our brochure, place an order with one of our agents, sit back and relax whilst we put the hard work into making it for you.

Every greenhouse which leaves our door is made with care, pride and attention to detail by our family so that it can be enjoyed by your family for generations to come.

60 YEAR ANNIVERSARY



WHY?

When it comes to choosing a greenhouse there is a lot of choice in today's market. Before you decide where to spend your money, we suggest you do your homework, have a good look around at everything on offer and compare the features and qualities of each manufacturer. A greenhouse should be a long lasting and enjoyable investment and you will obviously want a manufacturer who can offer the size and height you require, however, there are other factors which we feel you should consider which we know Elite can offer:

- 60 continuous years of successful British manufacturing, like our greenhouses we have stood the test of time.
- 10 Year Frame Guarantee as standard with every greenhouse we make.
- 9 Superb Colour Options to suit your garden environment. All aluminium accessories can also be powder coated.
- British Design and Manufacture with all components conforming to British Standards.
- No Automated Service – call us and speak to a real person who is happy to help.
- High Tensile Bolts – Elite's bolts have been scientifically tested to be 2 ½ times stronger than standard aluminium bolts, therefore, will not shear and continue to maintain the strength of your greenhouse throughout its lifetime.
- Bar Thickness – all Elite glazing bars will support a fixed shelf and staging, such as the diamond range - not all manufacturers can offer this.
- Stainless Steel Clips throughout which eradicates the fear of rust, warp and rot.
- Neoprene Beading – a cushion beading which has greater resistance to wind.
- Ensure there are no large gaps at the eaves section which would allow a significant ingress of water into the greenhouse.
- Glazing Options to suit budget and needs.
- Packages available on most greenhouses for even better value.
- Fantastic range of accessories available.
- Longer lengths – we can make your greenhouse to any length you require.



CONTENTS

What we have to offer you...



4' WIDE GREENHOUSES

6



5' WIDE GREENHOUSES

8



6' WIDE GREENHOUSES

10



7' & 8' WIDE GREENHOUSES

24



10' & 12' WIDE GREENHOUSES

40



EXTENSIONS & SPECIALS

46



LEAN-TO

48



R-TYPES

54



PACKAGES

56



GLAZING OPTIONS

58



POWDER COATING

59



BASE OPTIONS

60



CONSTRUCTION

62



WHERE TO BUY

62



DELIVERY

63

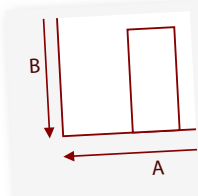

TECHNICAL INFO

64

4'3" WIDE COMPACT

Unlimited Lengths from 4'5"

For such a small building the Compact is packed with many features found on larger models, such as Double Doors and Elite's low threshold for easier access making this such a popular choice. If your growing space is limited, then the Compact offers a surprisingly spacious environment with an eaves height of 5' 1 1/2", and is an ideal building for the beginner.

All of our accessories are compatible with this model and package deals are available helping you increase the growing potential without breaking your budget.



Compact 4'x4' (Nominal), Integral Base, Alloy, Full Sheet Toughened Glass

THE COMPACT'S FRAME ACCOMMODATES SUPER STRENGTH DIAMOND INTEGRAL STAGING FOR A CLUTTER FREE, ELEGANT AND PRACTICAL WORKING AREA.

STANDARD FEATURES



GUTTER

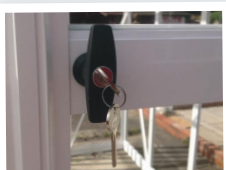

LOCKABLE



DOOR HANDLE











INTEGRAL BASE



EAVES CORNER

POWDER COATED

- | | |
|--|---|
|  Green |  White |
|  Black |  Olive |
|  Graphite |  Berry |
|  Brown |  Stone |
|  Terracotta | |

RECOMMENDED ACCESSORIES

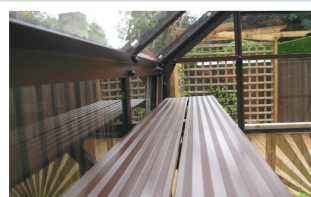

2 SLAT DIAMOND SHELF



3 SLAT DIAMOND SHELF/STAGING

4'3" WIDE MAXIM

Unlimited Lengths from 4'5"

The Maxim is ideal if your growing space is limited. One of the key differences compared to the Compact is the additional 7" of roof height, which can allow for a third shelf to be fitted and, together with taller doors, the result is a larger growing space.

As standard are the double doors and low threshold along with cantilever bracing for extra strength, a superb upgrade especially if the building is sited in a location more exposed to the elements. Package deals are available for this model making it one of the best performing greenhouses in the market place at this size.



Maxim 4'x4' (Nominal), Integral Base, Alloy, Full Sheet Toughened Glass



STANDING 5'8" HIGH AT THE EAVES GIVES YOU EXTRA GROWING SPACE.

STANDARD FEATURES

MAXIM ONLY



DOUBLE DOORS



LOW THRESHOLD

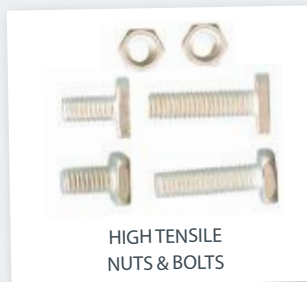

HIGH TENSILE NUTS & BOLTS



CANTILEVER

GLAZING

- Horticultural Glass
- Toughened Safety Glass
- 6mm Twin Wall Polycarbonate



ROOF VENT



6'x5' WIDE STREAMLINE

Unlimited Lengths from 4'5"

The long established Streamline by Elite remains a popular choice amongst growers with big aspirations from their smaller gardens or courtyards.

With large growing areas easily able to accommodate a combination of accessories, shelving and staging, together with the double doors and low threshold access, which are fitted as standard, superb performance is easily achieved from a 5'3" footprint.



Streamline 6'x5' (Nominal), Integral Base, Olive, Full Sheet Toughened Glass

THE STREAMLINE'S FRAME ACCOMMODATES SUPER STRENGTH DIAMOND INTEGRAL STAGING FOR A CLUTTER FREE, ELEGANT AND PRACTICAL WORKING AREA.

STANDARD FEATURES



GUTTER

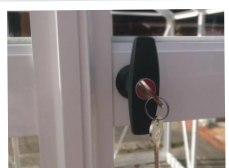

LOCKABLE



DOOR HANDLE



INTEGRAL BASE



EAVES CORNER

POWDER COATED

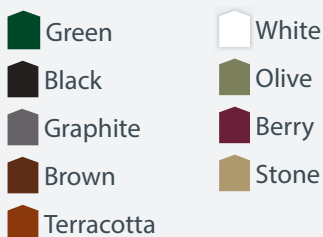

RECOMMENDED ACCESSORIES

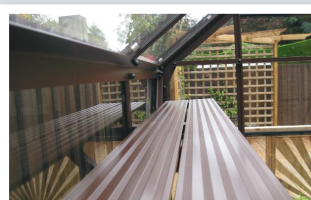

2 SLAT DIAMOND SHELF

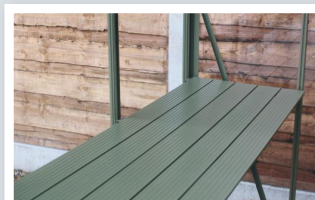

5 SLAT DIAMOND STAGING

5'3" WIDE DELTA

Unlimited Lengths from 4'5"

Thanks to the additional 11" of roof height, the Elite Delta pushes the boundaries of what can be achieved from a 5'3" greenhouse. With much more room, taller and bigger produce and accessories can easily be housed and the standard feature of double doors and low threshold access help increase the potential.

Our cantilever braces, again fitted as standard, offer extra strength making it an ideal choice for an environment exposed to the elements.



Delta 6'x5' (Nominal), Integral Base, Terracotta, Full Sheet Toughened Glass

STANDING 5'8" HIGH AT THE EAVES GIVES YOU EXTRA GROWING SPACE.

STANDARD FEATURES

DELTA ONLY



DOUBLE DOORS



LOW THRESHOLD

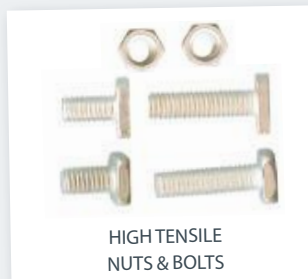

HIGH TENSILE NUTS & BOLTS

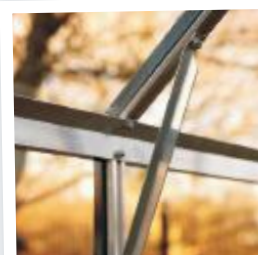

CANTILEVER

GLAZING

- Horticultural Glass
- Toughened Safety Glass
- 6mm Twin Wall Polycarbonate



ROOF VENT



6'3" WIDE iGRO

10



Available in
Aluminium
or Green

Available in 3 sizes:

4'5" x 6'3"

6'5" x 6'3"

8'5" x 6'3"

iGro 6'x6' (Nominal), Alloy, 4mm Twin Wall Polycarbonate

The budget stretching 6' wide iGro provides an entry footing into the Elite Greenhouse experience. Available only in 4'5", 6'5" and 8'5" lengths and with a choice of green or aluminium finishes, the 4mm Polycarbonate greenhouse can be delivered to you in

extra quick time. Included as standard is a vent and the low threshold access door found on many of the other Elite buildings, and with a superb package deal available too, if cost is your primary concern, then this greenhouse really will take some beating.

STANDARD FEATURES

1 1



ROOF VENT



LOW THRESHOLD



GUTTER

PACKAGE FOR 6'3" iGro



2 - 3'x 8" SHELVES



AUTOMATIC ROOF VENT



RAINWATER KIT

GLAZING

- P** 4mm Twin Wall Polycarbonate

POWDER COATED

- Green**

*The Shelves cannot be powder coated

**3-5
WORKING
DAY LEAD
TIME**

iGRO COLD FRAME

Ideal for seedlings and small plants, the Cold Frame is a must have in a gardener's armoury in the battle to "bring on" small plants fighting against the cold conditions.

Available in two sizes 4'x2' and 6'x2'

3- 5 working day lead time.

If you require the Cold Frame with Toughened Safety Glass or powder coated in a different Elite colour this can be done – please see page 41.

Available in
Aluminium
or Green



GLAZING

- P** 4mm Twin wall polycarbonate

6'3" WIDE CRAFTSMAN

1 2

Unlimited Lengths from 4'5"

For many years now, the Elite Craftsman has been a favoured choice for the serious grower and, at 6'3" wide, is one of the most popular sizes as it allows for superb storage space without taking away from a great workable area.

With Elite's fantastic packages available and such a wide choice of accessories and colours, you can easily tailor your Craftsman to work elegantly and effectively in your own environment.



Craftsman 10' x 6' (Nominal), Integral Base, Black, Full Sheet Toughened Glass

CHECK OUT OUR PACKAGE DEALS ON P56 TO GET THE MOST OUT OF YOUR GREENHOUSE

STANDARD FEATURES



GUTTER

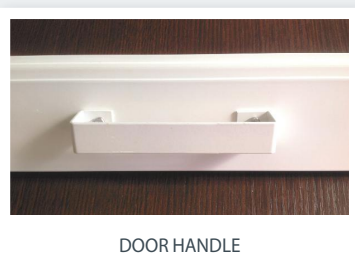

DOOR HANDLE











INTEGRAL BASE



EAVES CORNER

POWDER COATED

- | | |
|--|---|
|  Green |  White |
|  Black |  Olive |
|  Graphite |  Berry |
|  Brown |  Stone |
|  Terracotta | |

Take a look at our new
ACCESSORY BROCHURE
for all the extras you need
for your greenhouse.



6'3" WIDE HIGH EAVE

Unlimited Lengths from 4'5"

The High Eave adds an additional 11" of growing height into the same 6'3" wide greenhouse seen previously in the Craftsman.

The result is simply greater room for taller produce, a higher door for easier access and a more voluminous working space to accommodate practical accessories such as hanging basket rails or the superb 19" wide diamond staging. With a choice of packages and of course available in any of our coloured finishes, the outcome is a superb yet practical greenhouse from a very popular choice of size.



High Eave 8' x 6' (Nominal), Integral Base, Berry, Full Sheet Toughened Glass

THE 5'1" EAVES HEIGHT ALLOWS FOR EXTRA GROWING SPACE

STANDARD FEATURES

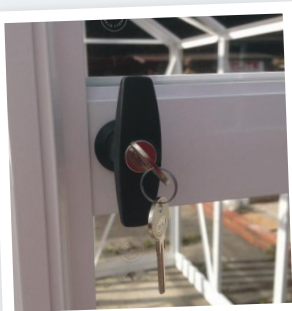

SINGLE LOCK



ROOF VENT



LOW THRESHOLD



CANTILEVER

GLAZING

-  Horticultural Glass
-  Toughened Safety Glass
-  6mm Twin Wall Polycarbonate

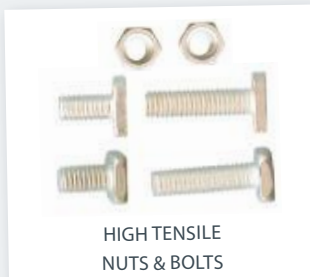

HIGH TENSILE NUTS & BOLTS



PACKAGES AVAILABLE
see p56 for details

6'3" WIDE STRATA

1 4

Unlimited Lengths from 4'5"



The 6'3" wide Elite Strata greenhouse stands head and shoulders above most other 6' wide models in the market. Thanks to the extra eaves height, your working space is increased giving a far healthier and stable environment for your products to flourish, as well as room for high level shelving, allowing you to maximise all of the usable areas in the greenhouse.

Fitted as standard with a double door, which is higher at 6'2" tall, the Strata features Elite's low level threshold doorway for ease of access when using a wheelbarrow or carrying heavy pots.



PACKAGES AVAILABLE see p56 for details

Strata 8'x6' (Nominal), Integral Base, Green, Full Sheet Toughened Glass

STANDARD FEATURES



GUTTER

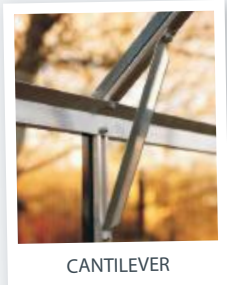

CANTILEVER



LOW THRESHOLD



EAVES CORNER



ROOF VENT



LOCKABLE



INTEGRAL BASE





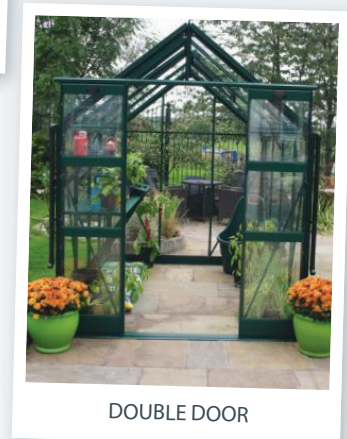





DOOR HANDLE



DOUBLE DOOR

POWDER COATED

-  Green
-  Black
-  Graphite
-  Brown
-  Terracotta
-  White
-  Olive
-  Berry
-  Stone

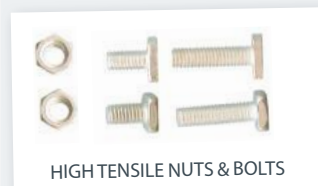

HIGH TENSILE NUTS & BOLTS

GLAZING

-  Horticultural Glass
-  Toughened Safety Glass
-  6mm Twin Wall Polycarbonate

HYBRID ALUMINIUM PANELS

- Available on all Elite Greenhouses and Lean-To (excluding iGro)
- Extremely strong and virtually unbreakable on impact
- Lawnmower / Strimmer friendly
- Impact from a ball or stones will simply bounce off
- Replaces part of the side glass – 585mm tall
- Hides unsightly grow bags
- Attractive appearance and can be powder coated to suit your greenhouse and garden environment
- Choose bar capping as an optional extra to finish



POWDER COATED

- Green
- Black
- Graphite
- Brown
- Terracotta
- White
- Olive
- Berry
- Stone



6'3" WIDE FEATURED DWARF WALL

Unlimited Lengths from 4'5"

The Dwarf Wall is a popular choice when the customer requires an eaves height of which part is brickwork and the remainder is glass and aluminium. The attractive, unique styling, often associated with a bygone era, is achieved from a combination of a traditional designed greenhouse yet without the cost and maintenance associated with a period wooden building. The 6' wide model comes with a single door, has Elite's low threshold and is only available with full sheet toughened safety glass which provides a neat and professional finish.

The bricks used should be a completely solid engineered brick with no holes and made to a good standard.

Why not finish your Dwarf Wall with Bar Capping and Cresting and Finials to complete the look.

When constructing a wall please only build your brick base once you have an official base plan from Elite.



Dwarf Wall 10'x6' (Nominal), Green, Full Sheet Toughened Glass

A Width	1912mm
B Door Width	644mm
C Brick Wall Height	762mm
D Eaves Height	1492mm
E Ridge Height	2325mm

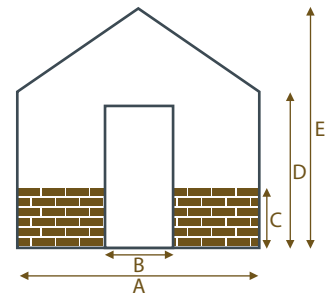

STANDARD FEATURES

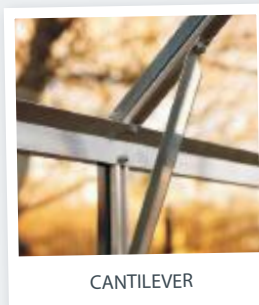
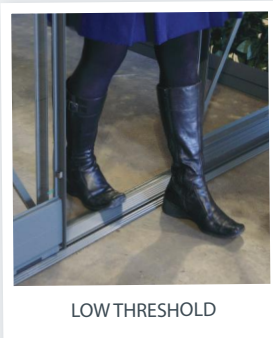

POWDER COATED

- Green
- Black
- Graphite
- Brown
- Terracotta
- White
- Olive
- Berry
- Stone

GLAZING

Toughened Safety Glass

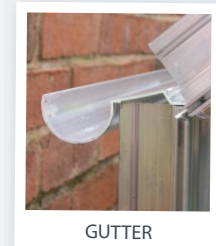
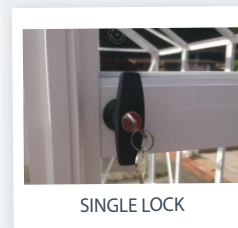









ALUMINIUM CRESTINGS & FINIALS

17

- Cast aluminium – extremely strong (not plastic)
- Available on all Elite Greenhouses (excluding iGro)
- Creates an individual and professional decorative finish
- Can be powder coated in any of Elite's colours
- Deterrent against cats and birds

POWDER COATED

- | | |
|---|---|
|  Green |  Olive |
|  Black |  Berry |
|  Graphite |  Stone |
|  Brown | |
|  Terracotta | |
|  White | |

6'3" WIDE GX600

Unlimited Lengths from 4'5"

18



PACKAGES
AVAILABLE
see p56 for
details

GX600 10'x6' (Nominal), Alloy, Full Sheet Toughened Glass

The GX600 will certainly make a statement in any garden or allotment. One of our premier models, this product is packed with superb features as standard to ensure that you get the best experience straight from the box.

A huge, airy and practical working space is achieved thanks to extra height double doors, extra high eaves, double roof vents and two side louvres along with full length hanging basket rails, a diamond shelf and our low threshold door entry. Immensely strong, with core-vect technology on both the gable and door end. With a stunning range of accessories, the GX is sure to enhance any outdoor space.







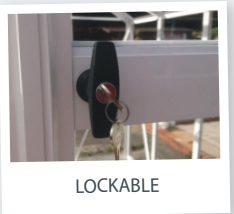
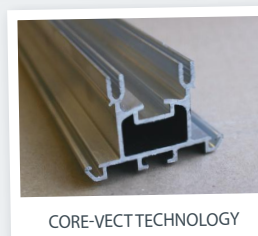
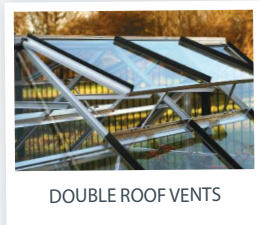
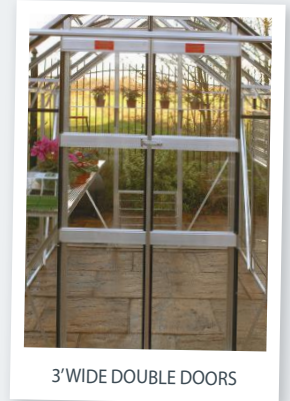
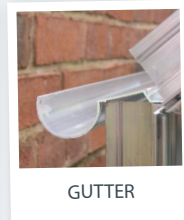
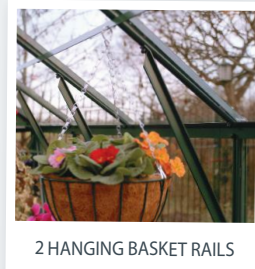
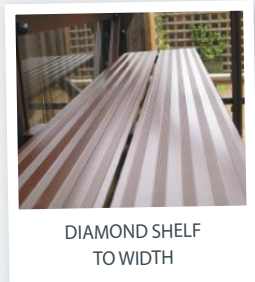



GX600 8'x6' (Nominal), Alloy, Full Sheet Toughened Glass

STANDARD FEATURES



POWDER COATED

-  Green
-  Brown
-  Olive
-  Black
-  Terracotta
-  Berry
-  Graphite
-  White
-  Stone

GLAZING

-  Horticultural Glass
-  Toughened Safety Glass
-  6mm Twin Wall Polycarbonate

RECOMMENDED ACCESSORIES

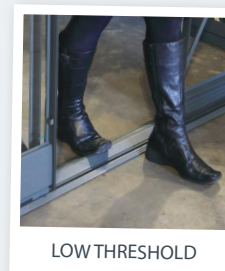

20

6'3" WIDE TITAN

Unlimited Lengths from 6'5"



DOUBLE
DOORS

PACKAGES
AVAILABLE
see p56 for
details

Titan 8'x6' (Nominal) in Russia, Intergral Base, Graphite, Full Sheet Toughened Glass

If strength is your primary factor when choosing your greenhouse then the Elite Titan is unsurpassable. Our greenhouses have always been renowned for strength, however, our Core-Vect Technology offers massively thicker framework than any product we have ever made before and more aluminium content than the leading competitors, which is why we feel there is no stronger greenhouse available in the UK today. With so many features included as standard, such as a generous double door opening with our low threshold access, a 10 blade louvre, canopy seals, cantilevers on every bar as well as being available as standard in alloy or a choice from nine sublime colours. With a fantastic range of accessories, Elite present a high definition greenhouse which is unique to the marketplace.



Titan 8'x6' (Nominal), Intergral Base, Green, Full Sheet Toughened Glass

STANDARD FEATURES

POWDER COATED



10 BLADE LOUVRE



INTEGRAL GUTTER



CANOPY SEAL





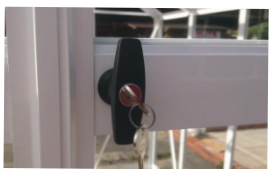





LOW THRESHOLD



LOCKABLE



EAVES CORNER

-  Green
-  Black
-  Graphite
-  Brown
-  Terracotta
-  White
-  Olive
-  Berry
-  Stone



INTEGRAL BASE



DOOR HANDLE



BAR CAPPING



ROOF VENT



CANTILEVERS

HOW STRONG IS STRONG?

Contact Elite for a free sample of the Titan bar before you make your decision. 01204 791488 enquiries@elite-greenhouses.co.uk

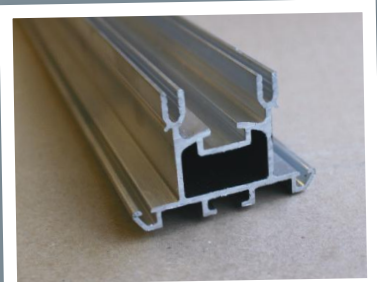

CORE-VECT TECHNOLOGY

GLAZING

T 4mm Toughened Safety Glass

P 6mm Twin Wall Polycarbonate

6'3" WIDE THYME DWARF WALL

22

Unlimited Lengths from 4'5"

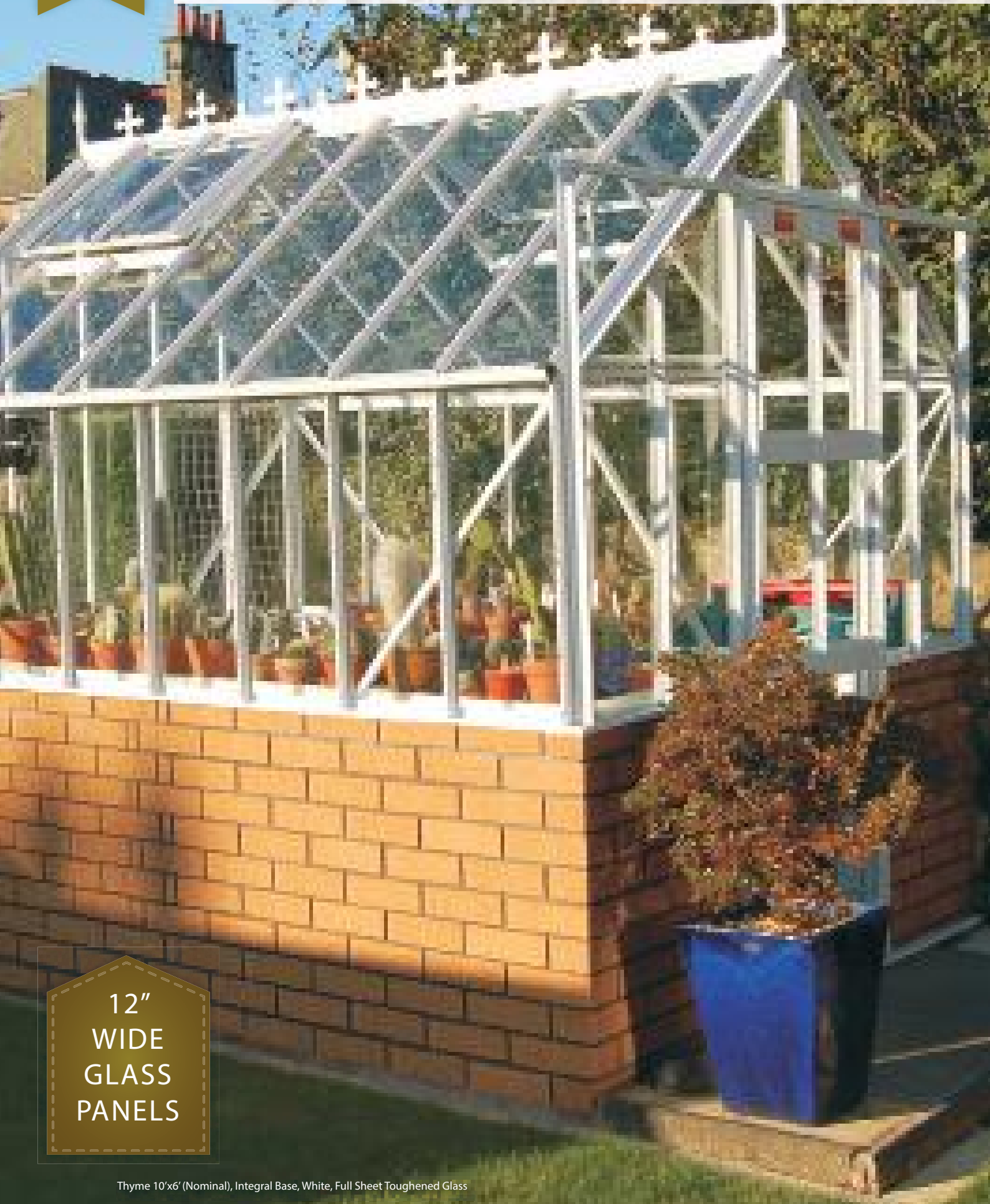

12"
WIDE
GLASS
PANELS

Thyme 10'x6' (Nominal), Integral Base, White, Full Sheet Toughened Glass

Practicality is fused with style and elegance in the Thyme greenhouse by Elite. Available in two guises, either as a freestanding model or a dwarf wall design, either of which can only be described as stunning.

Taking a design from a bygone era and bringing it to the present day packed with practical features as standard such as double doors, roof vents, 2 louvre vents, a diamond shelf, crestings and finials and our low threshold access. The Thyme is immensely strong thanks to the elegant 12" wide glass panels and still retains a fantastic growing space. Our superb range of accessories and wide choice of colours will complement arguably one of the most attractive greenhouses available today.

When constructing a wall please only build your brick base once you have an official base plan from Elite.

GLASS TO GROUND OPTION



Thyme 8'x6' (Nominal), Integral Base, Green, Full Sheet Toughened Glass

STANDARD FEATURES



2 LOUVRE VENTS



DIAMOND SHELF



EAVES CORNER



ROOF VENT

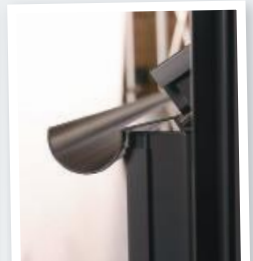

INTEGRAL GUTTER



DOOR HANDLE

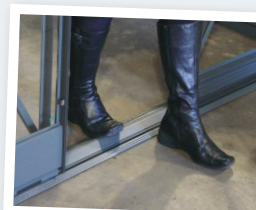

LOW THRESHOLD

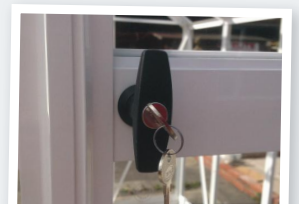

LOCKABLE

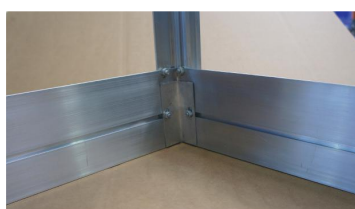

INTEGRAL BASE





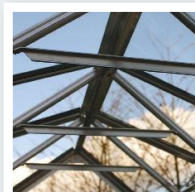





CRESTING & FINIALS



CANTILEVERS

POWDER COATED

-  Green
-  White
-  Black
-  Olive
-  Graphite
-  Berry
-  Brown
-  Stone
-  Terracotta

GLAZING

T Toughened Safety Glass

P 6mm Twin Wall Polycarbonate



7'5" WIDE VANTAGE

Unlimited Lengths from 4'5"

When your site area available is limited to 8' wide, previously your only option was to compromise and have a 6'4" wide greenhouse as any other models were simply too big.

The Vantage from Elite provides the answer as this all new size, 7'4", gives you the maximum sized building for your available base size without a compromise and includes double doors, cantilever braces, of course our superb low threshold access and all the accessories available to any model to allow a superb growing environment.



Vantage 16,x7' (nominal), Integral Base, Alloy, Full Sheet Toughened Glass, Internal Partition.

STANDARD FEATURES

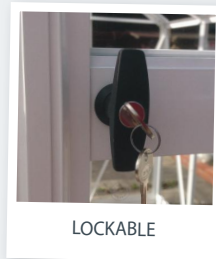
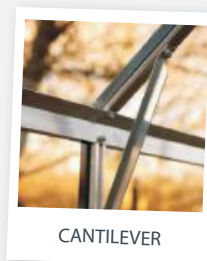
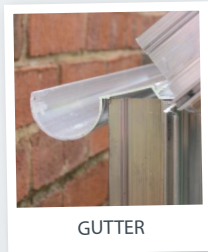

Take a look at our new ACCESSORY BROCHURE for all the extras you need for your greenhouse.



POWDER COATED

- | | | |
|----------|------------|-------|
| Green | Brown | Olive |
| Black | Terracotta | Berry |
| Graphite | White | Stone |

GLAZING

- Horticultural Glass
- Toughened Safety Glass
- 6mm Twin Wall Polycarbonate



7'5" WIDE TITAN 700

Unlimited Lengths from 6'5"

DOUBLE
DOORS

Titan 8'x7' (Nominal), Intergral Base, White, Full Sheet Toughened Glass

If strength is your primary factor when choosing your greenhouse then the Elite Titan is unsurpassable. Our greenhouses have always been renowned for strength, however, our Core-Vect Technology offers massively thicker framework than any product we have ever made before and more aluminium content than the leading competitors, which is why we feel there is no stronger greenhouse available in the UK today. With so many features included as standard, such as a generous double door opening with our low threshold access, a 10 blade louvre, canopy seals, cantilevers on every bar as well as being available as standard in alloy or a choice from nine sublime colours. With a fantastic range of accessories, Elite present a high definition greenhouse which is unique to the marketplace.

STANDARD FEATURES



10 BLADE LOUVRE

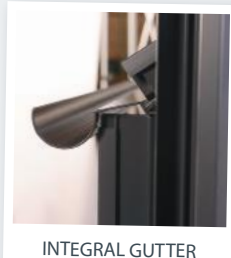

INTEGRAL GUTTER



CANOPY SEAL



LOCKABLE



LOW THRESHOLD



INTEGRAL BASE



DOOR HANDLE



BAR CAPPING



CANTILEVERS











ROOF VENT



EAVES CORNER

POWDER COATED

-  Green
-  Black
-  Graphite
-  Brown
-  Terracotta
-  White
-  Olive
-  Berry
-  Stone



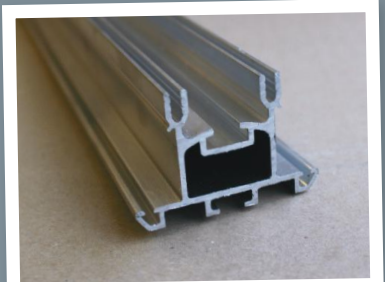

HOW STRONG IS STRONG?

Contact Elite for a free sample of the Titan bar before you make your decision. 01204 791488
enquiries@elite-greenhouses.co.uk



CORE-VECT TECHNOLOGY

GLAZING

-  4mm Toughened Safety Glass
-  6mm Twin Wall Polycarbonate



8'5" WIDE BELMONT

Unlimited Lengths from 4'5"



UPGRADE
TO DOUBLE
DOORS
MAKING
A 3' WIDE
OPENING

Belmont 10'x8' (Nominal), Double Door, Partition, Integral Base, Alloy, Full Sheet Toughened Glass

The long established Elite Belmont continues to thrive and remains an ever popular choice for customers.

A combination of a classic design and a wide range of features and accessories culminates in a well ventilated, healthy and large growing space and with optional extras such as partitions, double doors and our superb package deals, the outcome is a superb greenhouse in one of the most popular sizes.



Belmont 12'x8' (Nominal), Single Door, Integral Base, Alloy, Full Sheet Toughened Glass

STANDARD FEATURES

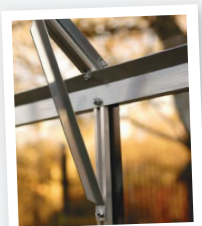

CANTILEVER BRACES



GUTTER



INTEGRAL BASE



EAVES CORNER



ROOF VENT



SINGLE LOCK











DOOR HANDLE



HIGH TENSILE NUTS & BOLTS

POWDER COATED

-  Green
-  Black
-  Graphite
-  Brown
-  Terracotta
-  White
-  Olive
-  Berry
-  Stone

ACCESSORIES



PARTITION

OPTIONAL UPGRADE



DOUBLE DOORS



LOW THRESHOLD

GLAZING

-  Horticultural Glass
-  Toughened Safety Glass
-  6mm Twin Wall Polycarbonate



30

8'5" WIDE MAIDEN 800

Unlimited Lengths from 6'5"

DOUBLE
DOORS

Maiden, 9'x8' (Nominal), Integral Base, Stone, Full Sheet Toughened Glass

The Maiden by Elite, the latest addition to our incredible range of greenhouses, is a design which is sure to create quite an impression in any garden. Available in any of our nine sublime power coated finishes, as well as the traditional standard alloy, this model offers an amazing amount of growing volume thanks to the incredible roof design. Standing in its 8 feet wide footprint, the greenhouse offers an eaves height of 1583mm found throughout our 8 feet range, and yet the ridge height stretches out to a colossal 3160mm, thus providing a cavernous growing area for taller produce and allows for superb air flow for all crops. Based on the DNA found in the Titan series, arguably the strongest greenhouse on the market, the Maiden has our thickest aluminium bar and has its own unique gutter to collect the rain water from such a huge roof space and, as standard, is supplied with the rainwater kit, automatic openers on all of its roof vents together with generous double doors with our low threshold access, a 10 blade louvre, canopy seals, cantilevers on every bar and crestings and finials for some added finesse. A truly voluminous greenhouse standing literally head and shoulders above the competition.

And you certainly will not miss the Maiden T-shape modification made specially for the Russian market.



Maiden T-shape modification greenhouse in Moscow

Toughened Safety Glass as standard

STANDARD FEATURES



10 BLADE LOUVRE



INTEGRAL GUTTER



CRESTINGS & FINIALS

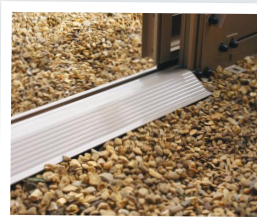

LOW THRESHOLD

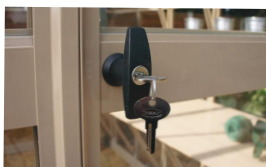

LOCKABLE



CANOPY SEAL



DOUBLE DOORS

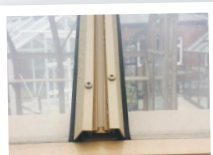

BAR CAPPING



RAIN WATER KIT



CANTILEVERS











INTEGRAL BASE



AUTOMATIC ROOF VENT

POWDER COATED

-  Green
-  Black
-  Graphite
-  Brown
-  Terracotta
-  White
-  Olive
-  Berry
-  Stone

HOW STRONG IS STRONG?

Contact Elite for a free sample of the Titan bar before you make your decision. 01204 791488
enquiries@elite-greenhouses.co.uk

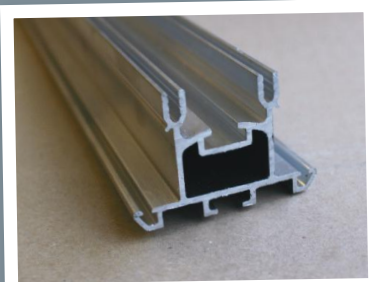

CORE-VECT TECHNOLOGY

GLAZING

T 4mm Toughened Safety Glass

P 6mm Twin Wall Polycarbonate

8'5" WIDE GX800

Unlimited Lengths from 6'5"



PACKAGES
AVAILABLE
see p56 for
details

GX800, 10'x8" (Nominal), Black, Full Sheet Toughened Glass









The GX800 will certainly make a statement in any garden or allotment. One of our premier models, this product is packed with superb features as standard to ensure that you get the best experience straight from the box.

A huge, airy and practical working space is achieved thanks to extra height double doors, extra high eaves, double roof vents and two side louvres along with full length hanging basket rails, a diamond shelf and our low threshold door entry. Immensely strong, with core-vect technology on both the gable and door end. With a stunning range of accessories, the GX is sure to enhance any outdoor space.

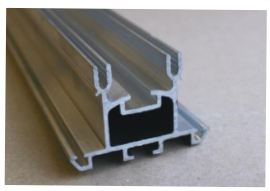
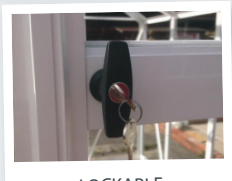

GX800 12'x8' (Nominal), Alloy, Full Sheet Toughened Glass

STANDARD FEATURES

 DIAMOND SHELF TO WIDTH	 2 LOUVRE VENTS	 2 HANGING BASKET RAILS	 GUTTER	 4' WIDE DOUBLE DOORS
 BAR CAPPING	 DOUBLE ROOF VENTS	 CORE-VECT TECHNOLOGY		
 LOCKABLE	 DOOR HANDLE	 CANTILEVERS		

RECOMMENDED ACCESSORIES



POWDER COATED

- | | | |
|----------|------------|-------|
| Green | Brown | Olive |
| Black | Terracotta | Berry |
| Graphite | White | Stone |

GLAZING

- Horticultural Glass
- Toughened Safety Glass
- 6mm Twin Wall Polycarbonate



8'5" WIDE TITAN 800

Unlimited Lengths from 6'5"



DOUBLE
DOORS

Titan, 10'x8' (Nominal), Integral Base, Graphite, Full Sheet Toughened Glass

If strength is your primary factor when choosing your greenhouse then the Elite Titan is unsurpassable. Our greenhouses have always been renowned for strength, however our Core-Vect Technology offers massively thicker framework than any product we have ever made before and more aluminium content than the leading competitors, which is why we feel there is no stronger greenhouse available in the UK today. With so many features included as standard, such as a generous double door opening with our low threshold access, a 10 blade louvre, canopy seals, cantilevers on every bar as well as being available as standard in alloy or a choice from nine sublime colours. With a fantastic range of accessories, Elite present a high definition greenhouse which is unique to the marketplace.



Titan, 6'x8' (Nominal), Integral Base, Graphite, Full Sheet Toughened Glass

STANDARD FEATURES



10 BLADE LOUVRE



INTEGRAL GUTTER



LOW THRESHOLD

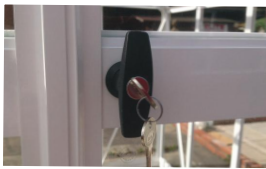

LOCKABLE



CANOPY SEAL



EAVES CORNER

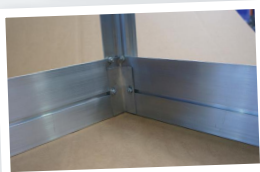

INTEGRAL BASE



DOOR HANDLE

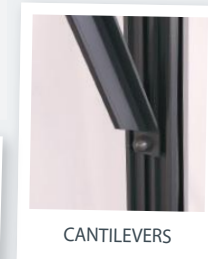

CANTILEVERS

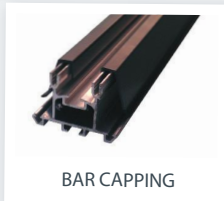









BAR CAPPING



ROOF VENT

POWDER COATED

-  Green
-  Black
-  Graphite
-  Brown
-  Terracotta
-  White
-  Olive
-  Berry
-  Stone

HOW STRONG IS STRONG?

Contact Elite for a free sample of the Titan bar before you make your decision. 01204 791488
enquiries@elite-greenhouses.co.uk

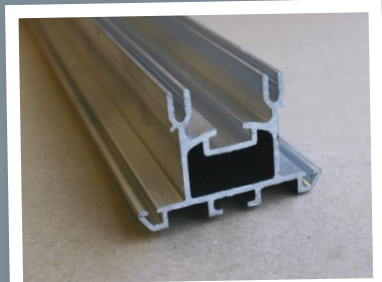

CORE-VECT TECHNOLOGY

GLAZING

T 4mm Toughened Safety Glass

P 6mm Twin Wall Polycarbonate

8'5" WIDE THYME DWARF WALL

Unlimited Lengths from 6'5"



Thyme, 14'x8' (Nominal) in Russia, White, Full Sheet Toughened Glass

12"
WIDE
GLASS
PANELS



Thyme, 12'x8' (Nominal) in Russia, Stone, Full Sheet Toughened Glass

GLASS TO GROUND OPTION

Practicality is fused with style and elegance in the Thyme greenhouse by Elite. Available in two guises, either as a freestanding model or a dwarf wall design, either of which can only be described as stunning.

Taking a design from a bygone era and bringing it to the present day packed with practical features as standard such as a 3' double door, roof vents, 2 louvre vents, a diamond shelf, crestings and finials and our low threshold access. The Thyme is immensely strong thanks to the elegant 12" wide glass panels and still retains a fantastic growing space. Our superb range of accessories and wide choice of colours will complement arguably one of the most attractive greenhouses available today.

When constructing a wall please only build your brick base once you have an official base plan from Elite.



Thyme, 10'x8' (Nominal), Integral Base, Black, Full Sheet Toughened Glass

STANDARD FEATURES



CANTILEVERS



DIAMOND SHELF



EAVES CORNER

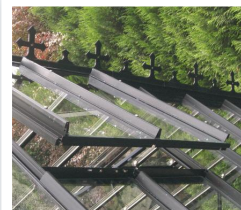

ROOF VENT



2 LOUVRE VENTS

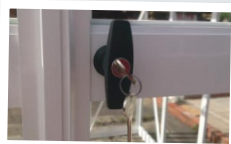

LOCKABLE



DOOR HANDLE



LOW THRESHOLD



INTEGRAL BASE

Glass to ground only





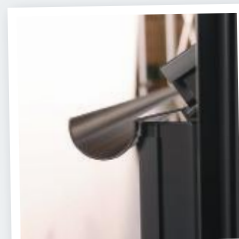





CRESTING & FINIALS



INTEGRAL GUTTER

POWDER COATED

-  Green
-  Black
-  Graphite
-  Brown
-  Terracotta
-  White
-  Olive
-  Berry
-  Stone

GLAZING

T Toughened Safety Glass

P 6mm Twin Wall Polycarbonate

8'5" WIDE FEATURED DWARF WALL

Unlimited Lengths from 6'5"

The Dwarf Wall is a popular choice when the customer requires an eaves height of which part is brickwork and the remainder is glass and aluminium. The attractive, unique styling, often associated with a bygone era, is achieved from a combination of a traditional designed greenhouse yet without the cost and maintenance associated with a period wooden building. The 8' wide model comes with a double door, has Elite's low threshold and is only available with full sheet toughened safety glass which provides a neat and professional finish.

The bricks used should be a completely solid engineered brick with no holes and made to a good standard.

Why not finish your Dwarf Wall with Bar Capping and Cresting and Finials to complete the look.

When constructing a wall please only build your brick base once you have an official base plan from Elite.



Dwarf Wall 10'x8' (Nominal), White, Full Sheet Toughened Glass



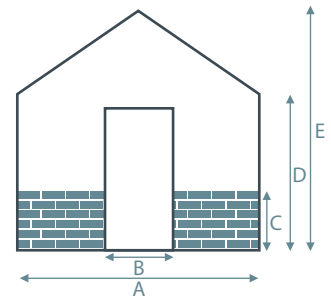



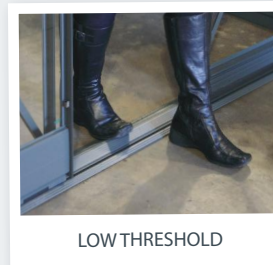
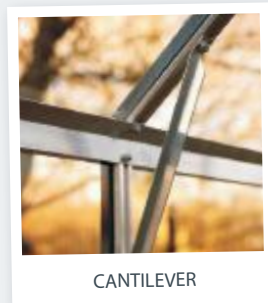

A Width	2570 mm
B Door Width	955 mm
C Brick Wall Height	762 mm
D Eaves Height	1662 mm
E Ridge Height	2538 mm



STANDARD FEATURES



POWDER COATED

-  Green
-  White
-  Black
-  Olive
-  Graphite
-  Berry
-  Brown
-  Stone
-  Terracotta

GLAZING

 Toughened Safety Glass

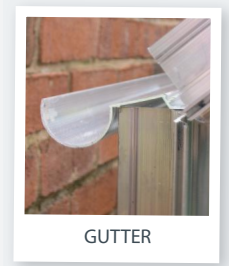
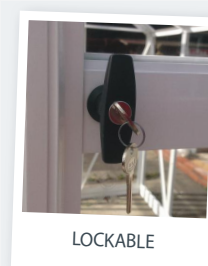



10'5" WIDE TITAN 1000

Unlimited Lengths from 6'5"



Titan, 20'x10' (Nominal) in Russia, Integral Base, Graphite, Full Sheet Toughened Glass

If strength is your primary factor when choosing your greenhouse then the Elite Titan is unsurpassable. Our greenhouses have always been renowned for strength, however our Core-Vect Technology offers massively thicker framework than any product we have ever made before and more aluminium content than the leading competitors, which is why we feel there is no stronger greenhouse available in the UK today. With so many

features included as standard, such as a generous double door opening with our low threshold access, a 10 blade louvre, canopy seals, cantilevers on every bar as well as being available as standard in alloy or a choice from nine sublime colours. With a fantastic range of accessories, Elite present a high definition greenhouse which is unique to the marketplace.



Titan, 20'x10' (Nominal) in Russia, Integral Base, Graphite, Full Sheet Toughened Glass

STANDARD FEATURES



10 BLADE LOUVRE



INTEGRAL GUTTER











DOOR HANDLE



EAVES CORNER

POWDER COATED

-  Green
-  Black
-  Graphite
-  Brown
-  Terracotta
-  White
-  Olive
-  Berry
-  Stone



LOW THRESHOLD

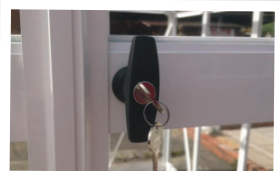

LOCKABLE



CANOPY SEAL

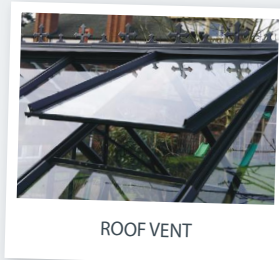

ROOF VENT



CANTILEVERS

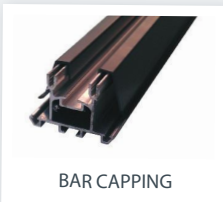

BAR CAPPING

HOW STRONG IS STRONG?

Contact Elite for a free sample of the Titan bar before you make your decision. 01204 791488
enquiries@elite-greenhouses.co.uk

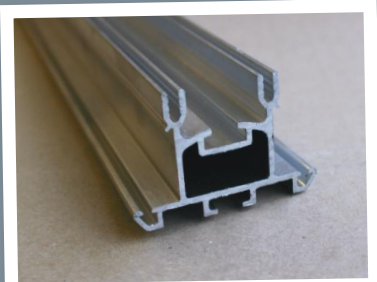

CORE-VECT TECHNOLOGY

GLAZING

T 4mm Toughened Safety Glass

P 6mm Twin Wall Polycarbonate

10'5" WIDE SUPREME

4 2

Unlimited Lengths from 4'5"



Supreme 20'x10' (Nominal) in Russia, Brown, Full Sheet Toughened Glass

For the larger garden setting or the grower with bigger ideas, the Supreme by Elite offers a superb greenhouse containing an amazing growing space. With two 5 blade

louvres, an 8' shelf and 3' wide double doors as standard this is a high performance greenhouse with the room and tools for some serious growing.

STANDARD FEATURES



DOUBLE DOORS



ROOF VENT



LOCKABLE



EXTRUDED SHELF



2-5 BLADE LOUVRES



GUTTER

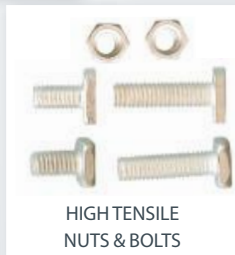

HIGH TENSILE NUTS & BOLTS



DOOR HANDLE

12'5" WIDE CLASSIQUE

Unlimited Lengths from 4'5"

43



Classique 16'x12' (Nominal), Green, Full Sheet Toughened Glass

The Classique is the professional's choice and offers an enormous uncompromised growing area. With all the standard features found on the Supreme, 4' wide double doors, a choice of powder coated finishes and a superb

range of accessories makes for a greenhouse with stunning looks and performance truly at home in the larger garden setting.

Take a look at our new **ACCESSORY BROCHURE** for all the extras you need for your greenhouse?

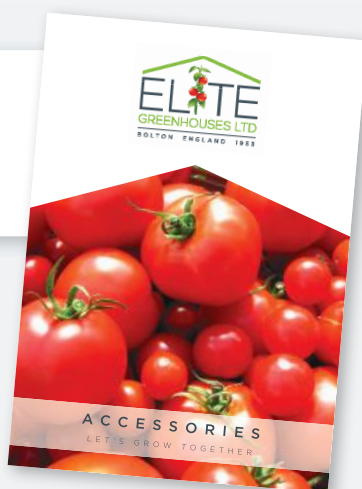

GLAZING

- H** Horticultural Glass
- T** Toughened Safety Glass
- P** 6mm Twin Wall Polycarbonate









RECOMMENDED ACCESSORIES



INTERNAL PARTITION

For extra stability and strength on the Supreme and Classique, Elite recommend building a brick base.

POWDER COATED

- | | |
|--|---|
|  Green |  White |
|  Black |  Olive |
|  Graphite |  Berry |
|  Brown |  Stone |
|  Terracotta | |

12'5" WIDE TITAN 1200

Unlimited Lengths from 6'5"



4' WIDE
DOUBLE
DOOR

Titan, 20'x10' (Nominal) in Russia, Integral Base, Graphite, Full Sheet Toughened Glass

If strength is your primary factor when choosing your greenhouse then the Elite Titan is unsurpassable. Our greenhouses have always been renowned for strength, however our Core-Vect Technology offers massively thicker framework than any product we have ever made before and more aluminium content than the leading competitors, which is why we feel there is no stronger greenhouse available in the UK today. With so many

features included as standard, such as a generous double door opening with our low threshold access, a 10 blade louvre, canopy seals, cantilevers on every bar as well as being available as standard in alloy or a choice from nine sublime colours. With a fantastic range of accessories, Elite present a high definition greenhouse which is unique to the marketplace.



Titan, 20'x10' (Nominal) in Russia, Integral Base, Graphite, Full Sheet Toughened Glass

STANDARD FEATURES

POWDER COATED



10 BLADE LOUVRE

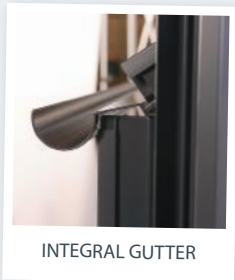









INTEGRAL GUTTER



DOOR HANDLE



EAVES CORNER

-  Green
-  Black
-  Graphite
-  Brown
-  Terracotta
-  White
-  Olive
-  Berry
-  Stone



LOW THRESHOLD

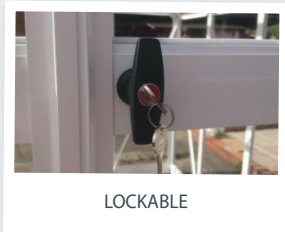

LOCKABLE

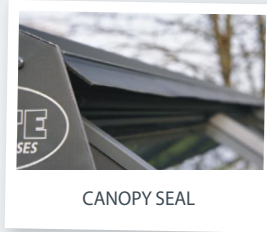

CANOPY SEAL

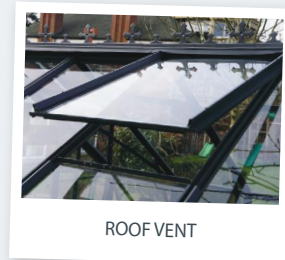

ROOF VENT

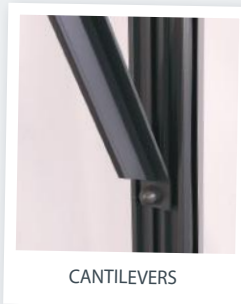

CANTILEVERS

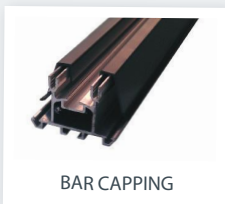

BAR CAPPING

HOW STRONG IS STRONG?

Contact Elite for a free sample of the Titan bar before you make your decision. 01204 791488 enquiries@elite-greenhouses.co.uk

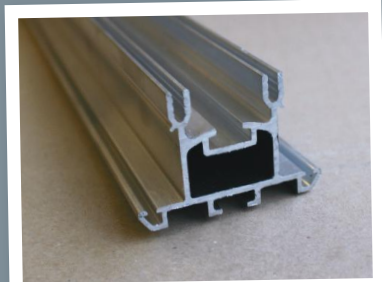

CORE-VECT TECHNOLOGY

GLAZING

T 4mm Toughened Safety Glass

P 6mm Twin Wall Polycarbonate

EXTENSIONS

Gardeners know that once your hobby grows you want to move onto bigger things.

"I just haven't got enough room for all my plants"

"I wish I'd purchased a bigger greenhouse"

"I can't afford to purchase a new, bigger greenhouse"

These are just a few of the comments we hear from customers who have been taken by the bug. In over 60 years of manufacturing our greenhouses, the answer to these questions has always been the same. Yes, we can make your greenhouse bigger!

All our greenhouses are made to the customers' specific length at the time of manufacture as we do not, unlike other manufacturers, make greenhouses in sections or with add ons. Each greenhouse can be made to unlimited lengths.

For you, the customer, to sell your current Elite and have to go and buy a new, bigger one not only sounds expensive but also unfair. Having made the initial investment and commitment to our products, like your produce, your greenhouse should be able to grow with you. With an Elite greenhouse then answer is that it can!!!



BEFORE 8'x6'



Please contact Elite or your nearest agent for more details.



AFTER 12'x6'



SPECIALS

As the manufacturer we feel that our range of products, sizes and specifications, which is the broadest range in the UK, covers pretty much every eventuality in a customer's choice and requirements. However, if you feel you have a specific need please get in touch and see if we can meet your special requirements.

DROP DOOR

A drop door modification is applied when the overall height of any Elite building needs to be increased.

It involves a brick wall being built by the customer to their desired height before a standard dimensional building is then constructed on top. A threshold is left in the wall for the door(s) to be dropped into and the cambered drop door then provides a neat and professional finish with the all important easy access.

As an optional extra, the doors can also be dropped on the larger greenhouse models (Supreme and Classique) and Lean-Tos providing a ground level threshold for easy access.



LEAN-TO

4 8

Unlimited Lengths from 4'5"

2'3" WIDE EASYGROW



Easygrow 6'x2' (Nominal), Green, Full Sheet Toughened Glass

A fitting name for a superb all round product, the Easygrow provides growing success from a reduced space without a reduction in quality and available features.

4'4" WIDE WINDSOR



Windsor 6'x4' (Nominal), Separate 5" Alloy Base, Alloy, Toughened Glass

A lower ridge height of 6'7", ideal for attachment to garages and sheds, is one of the main attractions of the Windsor making it a popular choice amongst gardeners.

STANDARD FEATURES



GUTTER



ROOF VENT

RECOMMENDED ACCESSORIES



SEPARATE 5" ALLOY BASE



BAYLISS XL



RAINWATER KIT

POWDER COATED



Green



Graphite



Terracotta



Olive



Stone



Black



Brown



White



Berry

GLAZING



Horticultural Glass



Toughened Safety Glass



6mm Twin Wall Polycarbonate

PACKAGES AVAILABLE
see p56 for details

Windsor Only

IGRO COLD FRAME

Ideal for seedlings and small plants, the Cold Frame is a must have in a gardener's armoury in the battle to "bring on" small plants fighting against the cold conditions. Tilt or slide top vents. Tilt vents are only intended for frame access.

Available in two sizes 4'x2' and 6'x2'.

Available in Aluminium or Green.

GLAZING

P 4mm Twin Wall Polycarbonate

**3-5
WORKING
DAY LEAD
TIME**



COLD FRAME



Tilt or slide top vents. Tilt vents are only intended for frame access. If you require the Cold Frame with Toughened Safety Glass or powder coated in a different Elite colour this can be done. Please note Elite's standard lead time will apply.

POWDER COATED

- Green
- Black
- Graphite
- Brown
- Terracotta
- White
- Olive
- Berry
- Stone

T Toughened Safety Glass

WINDOW GARDEN

If your circumstances result in little or no space whatsoever, then Elite's Window Garden can attach to walls or sheds and provide blossoming potential from a simple grow bag to a fully featured herb garden.

GLAZING

- H** Horticultural Glass
- T** Toughened Safety Glass
- P** 6mm Twin Wall Polycarbonate

POWDER COATED

- Green
- Black
- Graphite
- Brown
- Terracotta
- White
- Olive
- Berry
- Stone



EXTRA BASE TRAYS AVAILABLE

STANDARD FEATURES



GUTTER



SINGLE DOOR CATCH

LEAN-TO KENSINGTON

50

Unlimited Lengths from 4'5"

4'4" WIDE



Kensington 10'x4' (Nominal), Green, Full Sheet Toughened Glass



Kensington 8'x4' (Nominal), Separate 5" Alloy Base, Alloy, Horticultural Glass

6'4" WIDE



Kensington 22'x6' (Nominal), Green, Full Sheet Toughened Glass, Including Internal Partition



Kensington 22'x6' (Nominal), Separate 5" Alloy Base, Brown, Horticultural Glass, Including Internal Partition

Manufactured to any length, there are no limits when it comes to the three width sizes in the Kensington range. Packed full of features found in our freestanding models, these lean-to greenhouses bring the joys of the garden into the home.

PLEASE NOTE If your lean-to covers the entrance to a dwelling, you must have toughened safety glass throughout. If you have anything overhanging the ridge on a lean-to, please allow 1" (25mm) height clearance for the roof vent.

	A RIDGE HEIGHT (excluding any base)	B WIDTH (coming out of the wall)	C EAVES HEIGHT (excluding any base)	Door Height x Width (excluding any base)	Door Position Options SD=Single DD=Double (SD is supplied as standard)
4'4" KENSINGTON	7'4" (2235mm)	4'4" (1320mm)	5'11½" (1820mm)	Single Door 5'8½" x 1'11½" (1740x600mm)	SD on length and/or width DD on length (length over 8')
6'4" KENSINGTON	7'10½" (2400mm)	6'4½" (1940mm)	5'11½" (1820mm)	Double Door 5'8½" x 3'11½" (1740x1200mm)	

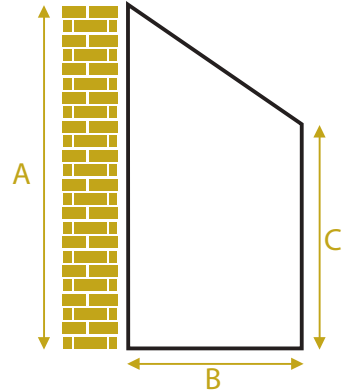

STANDARD FEATURES



EXTRUDED SHELF



5 BLADE LOUVRE



ROOF VENT

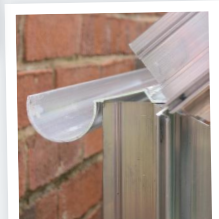

GUTTER

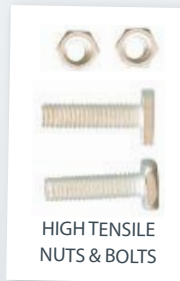

HIGH TENSILE
NUTS & BOLTS

POWDER COATED

- Green
- Black
- Graphite
- Brown
- Terracotta
- White
- Olive
- Berry
- Stone

GLAZING

- Horticultural Glass
- Toughened Safety Glass
- 6mm Twin Wall Polycarbonate

RECOMMENDED ACCESSORIES



SEPARATE 5" ALLOY BASE



AUTOMATIC LOUVRE



RAINWATER KIT



AUTOMATIC ROOF VENT

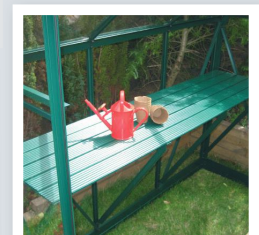

5 SLAT DIAMOND
STAGING

TITAN K800 LEAN-TO

5 2

Unlimited Lengths from 6'5"

8'4" WIDE



K800 18'x8' (Nominal), Brown, Full Sheet Toughened Glass



3'9"
WIDE
DOUBLE
DOOR

K800 12'x8' (Nominal), Green, Full Sheet Toughened Glass

- Heavy duty Core-Vect technology
- No base required – the lean-to is supplied with flat cills
- Tall 3'9" wide double doors – front or gable position
- One 5 blade louvre
- At least 1 roof vent
- Door lock & handle
- One 8' long Diamond shelf

When ordering, please inform your retailer the required door position.

HOW STRONG IS STRONG?
 Contact Elite for a free sample of the Titan bar before you make your decision. 01204 791488
 enquiries@elite-greenhouses.co.uk

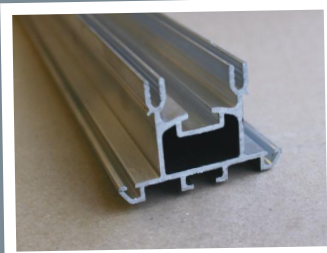

CORE-VECT TECHNOLOGY

PLEASE NOTE If your lean-to covers the entrance to a dwelling, you must have toughened safety glass throughout. If you have anything overhanging the ridge on a lean-to, please allow 1" (25mm) height clearance for the roof vent.

GLAZING

- T** 4mm Toughened Safety Glass
- P** 6mm Twin Wall Polycarbonate

STANDARD FEATURES



DIAMOND SHELF



5 BLADE LOUVRE



LOCKABLE



GUTTER



HIGH TENSILE NUTS & BOLTS



DOOR HANDLE



ROOF VENT



LOW THRESHOLD

POWDER COATED

- | | |
|------------|-------|
| Green | White |
| Black | Olive |
| Graphite | Berry |
| Brown | Stone |
| Terracotta | |

RECOMMENDED ACCESSORIES



BAR CAPPING



RAINWATER KIT



AUTOMATIC LOUVRE



AUTOMATIC ROOF VENT

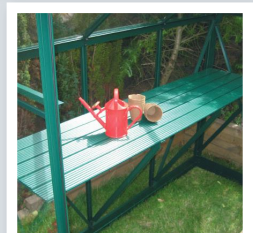

5 SLAT DIAMOND STAGING

R-TYPE

5 4

Unlimited Lengths from 4'5"

R-TYPE LEAN-TO



Kensington 6 R-Type 8'x6' (Nominal)

The Lean-to R-type offers similar principles allowing flexibility to the gardener regardless of the growing space available.

Through the removal of its gable end, the Lean-to R-type allows not only the length section of the framework to be attached to a wall but, also, one of the gable ends making it ideal to fit into a restrictive space with two walls, such as an alcove or any L shaped area.

Simply decide how far you would like the building to extend from the wall which is governed by the models available. The R-type, like the traditional Lean-to, can then be made to any length and the desired gable end will be removed once your order has been confirmed.

Once you have chosen your desired R-type, the standard features available to the traditional model will then apply.



Kensington 6 R-Type 12'x6' (Nominal)

A WIDTH (Coming out from the wall)	B LENGTH
EASYGROW 2'3" (700mm)	from 4'5"
WINDSOR 4'4" (1320mm)	from 6'6"
KENSINGTON 4 4'4" (1320mm)	from 6'5"
KENSINGTON 6 6'4" (1940mm)	from 6'5"
K 800 8'4" (2535mm)	from 6'5"

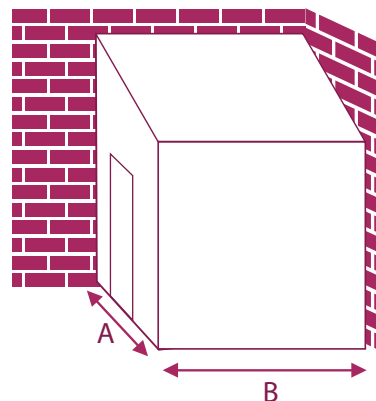

You can omit the left or right hand gable (must specify)



Kensington 6 R-Type 10'x6' (Nominal)

R-TYPE GREENHOUSE



Compact R-Type 6'x4' (Nominal)

The R-type from Elite offers flexibility for your gardening space. The R-type can fit into your garden set-up through the removal of the framework's rear end thus allowing it to become an integral part of a wall, shed or garage.

The important consideration with the freestanding R-type is the apex width, the section of the framework which will attach to your designated vertical surface which is governed by the width of any of our freestanding models. Once you have chosen your building, it can then be made to any required length from the wall.

Once you have chosen your desired R-type, the standard features available to the traditional model will then apply.



High Eave R-Type 2'x6' (Nominal)

A WIDTH

The R-Type width depends on which freestanding greenhouse model you choose.

Choose any model from pages 6 through to page 37.

B LENGTH (Depth from the wall)

Unlimited lengths starting from 2' (610mm)

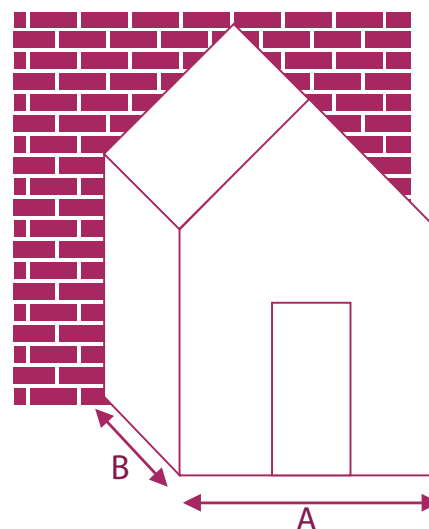

PACKAGES

We have designed our packages to help simplify choosing a greenhouse, to group together accessories to enable you to get started with a bang and to offer great value with one single price to pay.

The package features are in conjunction with the greenhouse's standard features.

Upgrade any package to toughened safety glass

PACKAGE 1 - MODELS AVAILABLE

4' wide (Compact & Maxim), 5' wide (Streamline & Delta), 6' wide (Craftsman, High Eave & Strata), 7' wide (Vantage), 8' wide (Belmont)

- Integral Base
- Low threshold door
- One 5 blade louvre vent
- One Elite automatic roof vent opener
- One automatic louvre vent opener
- Diamond 2 slat shelf to the length
- Diamond staging to the length
(number of slats depends upon the greenhouse width)
- Door lock
- Door handle
- Standard rainwater kit
- Grow hooks (6)

PACKAGE 2 – GX600 & GX800

- Low threshold double door
- One Bayliss MK7 automatic roof vent opener
- Two automatic louvre vent openers
- Diamond 2 slat shelf to the length
- Diamond staging to the length
(number of slats depends upon the greenhouse width)
- Door lock
- Door handle
- Standard rainwater kit
- Grow hooks (6)

PACKAGE 3 – WINDSOR LEAN-TO

- 5" separate aluminium base
- One 5 blade louvre vent
- One Elite automatic roof vent opener
- One automatic louvre vent opener
- Diamond 2 slat shelf to the length
- Diamond staging to the length
(number of slats depends upon the greenhouse width)
- Lean-to rainwater kit
- Grow hooks (6)

PACKAGE 4 – TITAN 600, 700 & 800

- Integral Base
- Low threshold door
- One Bayliss MK7 automatic roof vent opener
- One automatic louvre vent opener
- Diamond 2 slat shelf to the length
- Diamond staging to the length
(number of slats depends upon the greenhouse width)
- Door lock
- Door handle
- Standard rainwater kit
- Grow hooks (6)



3 Slat Diamond Staging



Auto Roof Vent Opener



Low Threshold Door



Door Handle

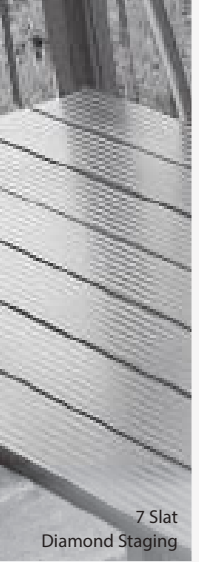

7 Slat Diamond Staging



5 Blade Louvre



Door Lock

POWDER COATING UPGRADE

-  Green
-  White
-  Black
-  Olive
-  Graphite
-  Berry
-  Brown
-  Stone
-  Terracotta



Auto Louvre Opener



5 Slat Diamond Staging



Rainwater Kit



Integral Base



2 Slat Diamond Staging

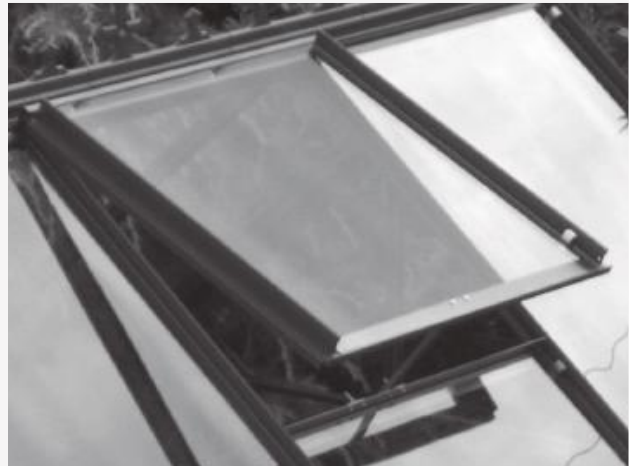

Bayliss MK7

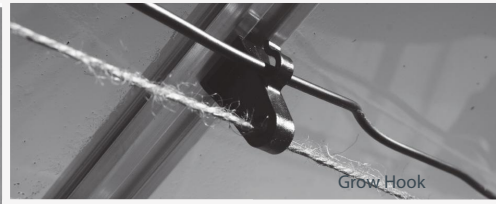

Grow Hook



GLAZING MATERIAL



HORTICULTURAL GLASS:

Available in 3mm thick overlapping glass sheets. Not recommended in roofs in Russia.



TOUGHENED SAFETY GLASS 4mm:

In the event of a breakage, the glass granulates removing any danger of injury. Elite only use Grade A toughened glass to Standard EN12150 which is primarily in full length sheets providing a neater finish, especially with bar capping, and removes any overlapping glass where algae and moss can often be a problem.



POLYCARBONATE:

UVI treated, twin wall with silvered edges and, like the toughened safety glass, it comes in full sheets and is a great option where children and pets are concerned. Elite offer 6mm thick on every model.

We do not recommend polycarbonate in Russia though.

Remember, when handling any type of glass the utmost care must be taken as it is extremely fragile when not in situ. Always protect your hands and eyes when handling glass and we advise that safety gloves and goggles are worn.

BAR CAPPING

Bar Capping provides a stronger hold for the glazing and adds a decorative finish to any greenhouse. The rubber fin also adds a better water seal between the frame and glass. Capping is used in addition to wire clips so in effect will add double protection which is ideal in more exposed areas.

The capping is simply screwed into position using colour coded screws which do not leave any unsightly silver screw heads on show.

Not recommended with overlapping glass.



GREEN



BLACK



GRAPHITE



BROWN



TERRACOTTA



WHITE



OLIVE



BERRY

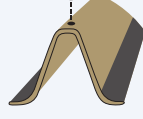

STONE

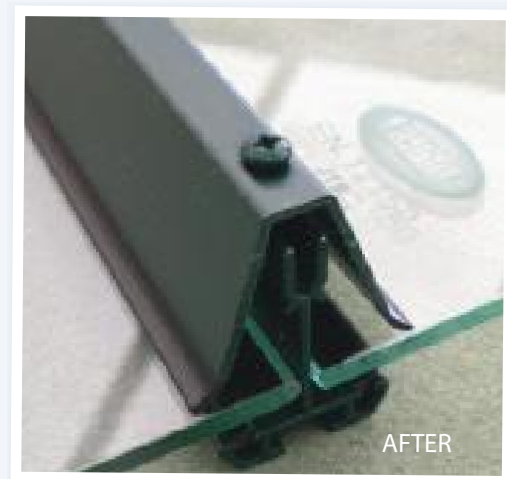

POWDER COATING

- High class, hard wearing, professional powder coated finish
- Available in nine attractive colours – Green, Graphite, Black, White, Brown or Terracotta
- Co-ordinate with your garden environment
- Has been thoroughly tried and tested and has been available to Elite customers for over 20 years
- Environmentally friendly way of applying colour to aluminium unlike wet paint which requires the use of solvents
- Most aluminium accessories can also be powder coated to suit your greenhouse
- A good depth of colour
- The frame is resistant to corrosion, UV degradation and offers a life expectancy in excess of 25 years
- All Elite's frames are individually wrapped in polythene and labelled for added protection during transportation and storage
- Elite provide nut caps with all powder coated models and accessories to give a nice, clean, professional finish to your product by covering up any unsightly nuts and bolts.

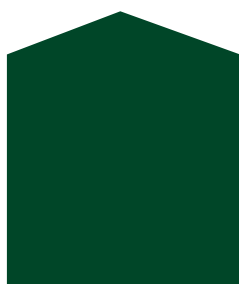
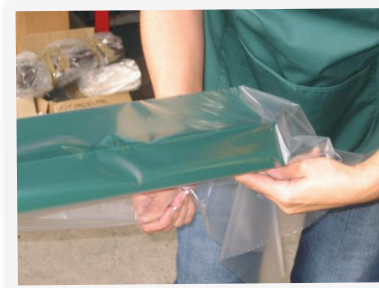

Green



Black



Graphite



Brown



Terracotta



White



Olive



Berry



Stone

BASES

THE MOST POPULAR METHOD IS TO LAY A LEVEL FLAGGED AREA.

Please remember to build your slabs slightly bigger than the greenhouse size, as this gauge is only nominal and the product is actually a few inches bigger. For example, for an 8'x6' greenhouse you might want to consider a slab area of 10'x8' as this will allow you to position water barrels and will also allow enough room to get around the greenhouse to clean and maintain.



SOFT GROUND

The majority of greenhouses are constructed onto a solid foundation however if your greenhouse is being constructed onto soil or grass, persistent stepping on the door cill will cause damage as it will naturally follow the contour of the ground. A hard support, such as flags, must be fitted under the cill and Elite recommend using their soft soil support which allows the door(s) to run in the track.

Hard or soft surface, Elite provide, as standard, both options to anchor the base down.



FREE STANDING GREENHOUSE UP TO 8' WIDE

Elite, as standard, offer only aluminium bases which are an integral part of the framework giving additional strength - the stronger the base the better! Elite only supply bases made from aluminium therefore removing the fear of rust, rot or warping. Due to the fact Elite's aluminium bases are an integral part of the framework, this has allowed us to manufacture a low threshold door which also means the door(s) are taller. As standard the door(s) are "dropped" into the base providing a ground level threshold allowing easy access for the user. Please note a base is not required on the iGro or GX range.



LARGER GREENHOUSES

- 10' & 12' WIDE

For extra stability and strength on the larger models we recommend building a brick base. A solid engineering brick should always be used, however, please note that the number of bricks used in the base height will result in a higher step-over into the greenhouse. Overlapping cills demonstrate a need for accuracy when building a brick base. As an optional extra the door(s) can also be dropped into the brick work to allow wheelchair and wheelbarrow access. Please refer to the technical information on page 64 for exact measurements.

As an optional extra, Elite offer an integral aluminium base with drop doors giving low level threshold for the 10' and 12' wide greenhouses.



OPTIONAL EXTRA

LEAN-TO

Elite offer a separate 5" aluminium base on all Lean-Tos as an optional extra. The aluminium base is versatile in that it has the ability to go directly onto soil or grass and can be adapted for any solid foundation, such as concrete slabs.

The lean-to base does not have a ground level threshold as standard, however as an optional extra the door(s) can be dropped into the aluminium base/brick work to achieve this.

On the Titan K800 Lean-To no base is required. The Lean-To is supplied with flat cills. However, (as an optional extra) Elite offer an integral aluminium base with drop doors giving low level threshold should a base be required.



OPTIONAL EXTRA

CONSTRUCTION

Every Elite comes with its own set of comprehensive instructions. The level of difficulty assembling each model depends solely upon the competence of the individual. For most sized greenhouses, depending upon ability, speed and helpers available to you, a building can be completed within a weekend. However, we recommend you take your time in constructing your greenhouse, plan each stage of the build and follow the instructions carefully.

Anyone with a reasonable level of practical ability can construct an Elite easily, however, the majority of garden centres operate a construction service in the event of you preferring it to be done for you. This offers peace of mind that the product has been assembled correctly.

Tools needed:

Step ladders, M6 – M10 Spanner, Pozi Drive screwdriver, Gloves, Goggles



For additional guidance during construction visit our website and watch our helpful video tutorials. www.elite-greenhouses.co.uk

WHERE TO BUY

Today's budding gardeners and enthusiasts have many avenues available to them with regards to sourcing an Elite product. We, as the manufacturer, do not sell direct to the general public, but instead supply garden centres and garden building outlets across the UK. Many dealers appear in magazines, flower shows and on the internet and offer show sites where you can actually go and view a fully constructed product.

If you are unsure where to begin, then simply contact us directly on 01204 791488 or email us at enquiries@elite-greenhouses.co.uk. One of our staff will be more than happy to provide you with details of your local suppliers.





Elite deliver the majority of greenhouses direct to your door, nationwide, using our own fleet of vehicles. Customers based in Ireland, parts of Scotland and other off shore locations can arrange their delivery through local agents.

Our vehicles are Class II 15 ton lorries, similar in dimensions to a furniture removal van, so if you have access restrictions to your property then please contact your supplier to discuss an alternative address and to clarify your postcode for the delivery route.

The exception to our delivery policy is where some garden centres, or dealers, stock levels of products to reduce costs and delivery lead times and, in these instances, the delivery will be arranged by them. This will also apply if your stockist has arranged to construct your product for you.

Our lead times are only for guidance so please check with your stockist as they can vary throughout the year. Please inform your stockist if you are unable to take delivery at any time.

Our drivers are accustomed to delivering to unattended properties and will deposit wherever you require and post the paperwork through your letter box to enable you to check the items on your return.

If you know your address is difficult to find, or there is something unusual about your address (like the postcode doesn't bring you anywhere near your house) let your agent know at the time of ordering.



TECHNICAL INFO

Long lengths are available on every model listed.

Please contact your supplier for a base plan for any size or modification (Drop Door, Dwarf Wall, Partition etc.) not listed on this page.

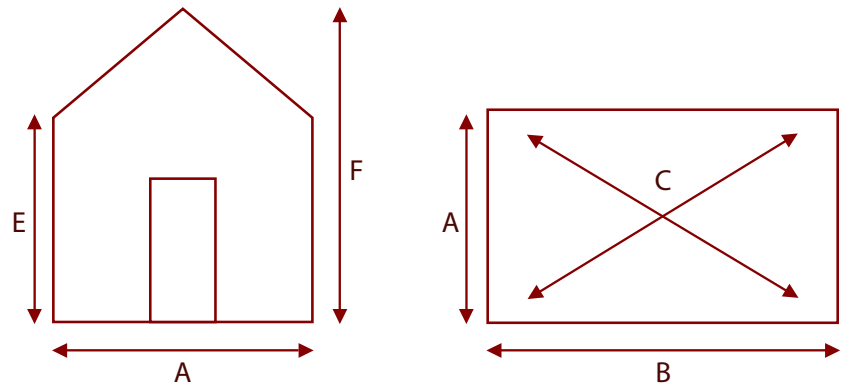

When constructing a wall please only build your brick base once you have an official base plan from Elite.

Exact base dimensions for Elite range (where required). The following measurements are external dimensions... Please note the width at the gutter is wider than the base.

Nominal Size (ft)	Model Name	A (mm)	B (mm)	C (mm)	E (mm)	F (mm)	Door Height x Width	Single Door	Double Door	Base	Low Threshold Door	Roof Vents	Louvre Vents	Shelf	Bar Capping	Crestings & Finials	Partition	Dwarf Wall		
4 x 4	Compact	1300	1351	1874	1553 with BIB	2122 with BIB	Double 1750 x 600		●	BIB	●	1	○	○	○	○		○		
6 x 4	Compact	1300	1971	2361				●	1		○	○	○	○	○	○	○		○	
8 x 4	Compact	1300	2589	2897				●	1		○	○	○	○	○	○	○		○	
4 x 4	Maxim	1300	1351	1874	1726 with BIB	2300 with BIB	Double 1910 x 600		●	BIB	●	1	○	○	○	○	○	○		
6 x 4	Maxim	1300	1971	2361				●	1		○	○	○	○	○	○	○		○	
8 x 4	Maxim	1300	2589	2897				●	1		○	○	○	○	○	○	○		○	
4 x 5	Streamline	1590	1351	2086	1425 with BIB	2122 with BIB	Double 1750 x 600		●	BIB	●	1	○	○	○	○	○	○		
6 x 5	Streamline	1590	1971	2532				●	1		○	○	○	○	○	○	○		○	
8 x 5	Streamline	1590	2589	3038				●	1		○	○	○	○	○	○	○		○	
4 x 5	Delta	1590	1351	2086	1726 with BIB	2420 with BIB	Double 1910 x 600		●	BIB	●	1	○	○	○	○	○	○		
6 x 5	Delta	1590	1971	2532				●	1		○	○	○	○	○	○	○		○	
8 x 5	Delta	1590	2589	3038				●	1		○	○	○	○	○	○	○		○	
4 x 6	iGro	1915	1363	2348	1350	2180	Single 1750 x 600	●		No Base required	●	1		○						
6 x 6	iGro	1915	1981	2753				●	1			○								
8 x 6	iGro	1915	2600	3228				●	1			○								
4 x 6	Craftsman	1900	1351	2331	1292 with BIB	2122 with BIB	Single 1750 x 600	●		BIB	●	1	○	○	○	○	○	○		
6 x 6	Craftsman	1900	1971	2737				●	1		○	○	○	○	○	○	○		○	
8 x 6	Craftsman	1900	2589	3211				●	2		○	○	○	○	○	○	○		○	
10 x 6	Craftsman	1900	3205	3725				●	2		○	○	○	○	○	○	○		○	
12 x 6	Craftsman	1900	3823	4269	●	2	○	○	○	○	○	○	○		○					
4 x 6	High Eave	1900	1351	2331	1585 with BIB	2420 with BIB	Single 1910 x 600		●	BIB	●	1	○	○	○	○	○	○		
6 x 6	High Eave	1900	1971	2737				●	1		○	○	○	○	○	○	○		○	
8 x 6	High Eave	1900	2589	3211				●	2		○	○	○	○	○	○	○		○	
10 x 6	High Eave	1900	3205	3725				●	2		○	○	○	○	○	○	○		○	
12 x 6	High Eave	1900	3823	4269	●	2	○	○	○	○	○	○	○		○					
4 x 6	Strata	1900	1351	2331	1585 with BIB	2420 with BIB	Double 1910 x 840		●	BIB	●	1	○	○	○	○	○	○		
6 x 6	Strata	1900	1971	2737				●	1		○	○	○	○	○	○	○		○	
8 x 6	Strata	1900	2589	3211				●	2		○	○	○	○	○	○	○		○	
10 x 6	Strata	1900	3205	3725				●	2		○	○	○	○	○	○	○		○	
12 x 6	Strata	1900	3823	4269	●	2	○	○	○	○	○	○	○		○					
4 x 6	GX600	1936	1373	2373	1631	2470	Double 1910 x 840		●	No Base required	●	1	2	6' Diamond Shelf	●	○	○	○		
6 x 6	GX600	1936	1993	2779				●	1		2	●	○		○	○				
8 x 6	GX600	1936	2611	3250				●	2		2	●	○		○	○				
10 x 6	GX600	1936	3227	3763				●	2		2	●	○		○	○				
12 x 6	GX600	1936	3845	4305				●	2		2	●	○		○	○				
4 x 6	Thyme 6 - Floor	1900	1351	2331	1585 with BIB	2420 with BIB	Double 1910 x 600		●	BIB	●	1	2	6' Diamond Shelf	○	●	○	○		
6 x 6	Thyme 6 - Floor	1900	1971	2737				●	1		2	○	●		○	○				
8 x 6	Thyme 6 - Floor	1900	2589	3211				●	2		2	○	●		○	○				
10 x 6	Thyme 6 - Floor	1900	3205	3725				●	2		2	○	●		○	○				
12 x 6	Thyme 6 - Floor	1900	3823	4269	●	2	2	○	●	○	○									
6 x 6	Titan 600	1900	1971	2737	1585 with BIB	2420 with BIB	Double 1910 x 840		●	BIB	●	1	1	○	●	○	○	○		
8 x 6	Titan 600	1900	2589	3211				●	2		1	○	●	○	○					
10 x 6	Titan 600	1900	3205	3725				●	2		1	○	●	○	○					
12 x 6	Titan 600	1900	3823	4269				●	2		1	○	●	○	○					
6 x 7	Vantage	2225	1971	2972	1585 with BIB	2370 with BIB	Double 1910 x 890		●	BIB	●	1	○	○	○	○	○	○		
8 x 7	Vantage	2225	2589	3413				●	2		○	○	○	○	○					
10 x 7	Vantage	2225	3205	3901				●	2		○	○	○	○	○					
12 x 7	Vantage	2225	3823	4423				●	2		○	○	○	○	○					
14 x 7	Vantage	2225	4441	4967				●	3		○	○	○	○	○					
16 x 7	Vantage	2225	5059	5526				●	4		○	○	○	○	○					
18 x 7	Vantage	2225	5677	6097				●	5		○	○	○	○	○					
20 x 7	Vantage	2225	6295	6676				●	6		○	○	○	○	○					

TECHNICAL INFO

Long lengths are available on every model listed.

Please contact your supplier for a base plan for any size or modification (Drop Door, Dwarf Wall, Partition etc.) not listed on this page.

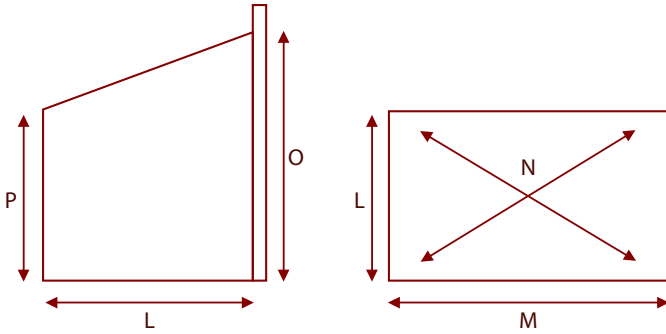

If you have anything overhanging the ridge on a lean-to, please allow 1" (25mm) height clearance for the roof vent.

KEY

● : Standard Features

○ : Optional Extra

BIB : Built in Base

O - BIB : Optional Built in Base

O - SB : Optional 5" Separate Aluminium Base

R - BB : Recommended Brick Base

BRK : Brick Wall

SD - L : Single Door available on Length only

SD - W : Single Door available on Width only

SD - LW : Single Door available on Length and/or Width

O - DD : Optional Double Door on Length (and/or Width if over 8')

Nominal Size (ft)	Model Name	L (mm)	M (mm)	N (mm)	O (mm)	P (mm)	Door Height x Width	Single Door	Door Position	Base	Low Threshold Door	Roof Vents	Louvre Vents	Shelf	Bar Capping	Crestings & Finials	Partition	Dwarf Wall				
4 x 2	Easygrow	670	1346	1504	1830	1590	1500 x 600	●	SD - L	O - SB	○	1	○	○	○			○				
6 x 2	Easygrow	670	1964	2067	Ex Base	Ex Base	1500 x 600	○			○	○	○	○	○	○	○			○		
8 x 2	Easygrow	670	2582	2638			1500 x 1200	Double			○	○	○	○	○	○	○	○			○	
6 x 4	Windsor	1297	1960	2349	2010	1590	1600 x 600	●	SD - W	O - SB	○	1	○	○	○			○				
8 x 4	Windsor	1297	2578	2885				○			1	○	○	○	○	○	○	○			○	
10 x 4	Windsor	1297	3196	3448				○			1	○	○	○	○	○	○	○			○	
12 x 4	Windsor	1297	3814	4028				○			1	○	○	○	○	○	○	○			○	
6 x 4	Kensington	1297	1960	2349	2235	1800	Single 1750 x 600	●	SD-LW	O - SB	○	1	1	4' Extruded Shelf	○			○				
8 x 4	Kensington	1297	2578	2885				○			1	1	○		○	○	○	○			○	
10 x 4	Kensington	1297	3196	3448				○			1	1	○		○	○	○	○			○	
12 x 4	Kensington	1297	3814	4028				○			1	1	○		○	○	○	○			○	
6 x 6	Kensington	1915	1960	2740	2400	1800	Single 1750 x 600	●	SD-LW	O - SB	○	1	1	6' Extruded Shelf	○			○				
8 x 6	Kensington	1915	2578	3211				○			1	1	○		○	○	○	○			○	
10 x 6	Kensington	1915	3196	3725				○			1	1	○		○	○	○	○			○	
12 x 6	Kensington	1915	3814	4267				○			1	1	○		○	○	○	○			○	
6 x 8	Titan	2534	1991	3223	2743	1950	Double 1910 x 1150	Double Door	Gable Double Doors	No Base required	●	1	1	8' Diamond Shelf	○			○				
8 x 8	Titan	2534	2609	3637							●	1	1		○	○	○	○	○			○
10 x 8	Titan	2534	3227	4103							●	1	1		○	○	○	○	○			○
12 x 8	Titan	2534	3845	4605							●	1	1		○	○	○	○	○			○
14 x 8	Titan	2534	4463	5132							●	2	1		○	○	○	○	○			○
16 x 8	Titan	2534	5081	5678							●	2	1		○	○	○	○	○			○
18 x 8	Titan	2534	5699	6237							●	3	1		○	○	○	○	○			○
20 x 8	Titan	2534	6319	6809							●	3	1		○	○	○	○	○			○
6 x 8	Titan	2569	1954	3228	2743	1950	Double 1910 x 1150	Double Door	Front Double Doors	No Base required	●	1	1	8' Diamond Shelf	○			○				
8 x 8	Titan	2569	2572	3635							●	1	1		○	○	○	○	○			○
10 x 8	Titan	2569	3190	4096							●	1	1		○	○	○	○	○			○
12 x 8	Titan	2569	3808	4594							●	1	1		○	○	○	○	○			○
14 x 8	Titan	2569	4426	5118							●	2	1		○	○	○	○	○			○
16 x 8	Titan	2569	5044	5661							●	2	1		○	○	○	○	○			○
18 x 8	Titan	2569	5662	6218							●	3	1		○	○	○	○	○			○
20 x 8	Titan	2569	6280	6758							●	3	1		○	○	○	○	○			○

COLD FRAME

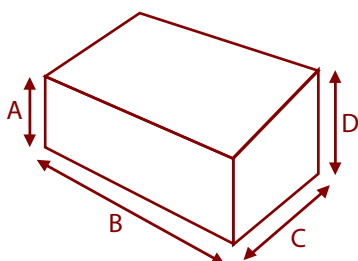

- A 1'6" (460mm)
- B 4'4³/₄" (1340mm) or 6'7" (2000mm)
- C 2'1¹/₄" (640mm)
- D 1'8¹/₂" (520)

WINDOW GARDEN

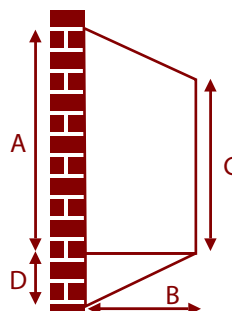

- A 5'1¹/₂" (1560mm)
- B 1'5¹/₂" (440mm)
- C 4' (1210mm)
- D 1'7" (480mm)

Door Height x Width
3'8¹/₂" x 11"
(1130 x 280mm)
length
3'10" (1170mm)





LET'S GROW TOGETHER

MOSCOW OFFICE

+7985 13 44444, +79 777 444444

info@britton.ru

enquiries@elite-greenhouses.co.uk | www.elite-greenhouses.co.uk